

ATLAS 55 LED UP-DOWN

SUSPENDED

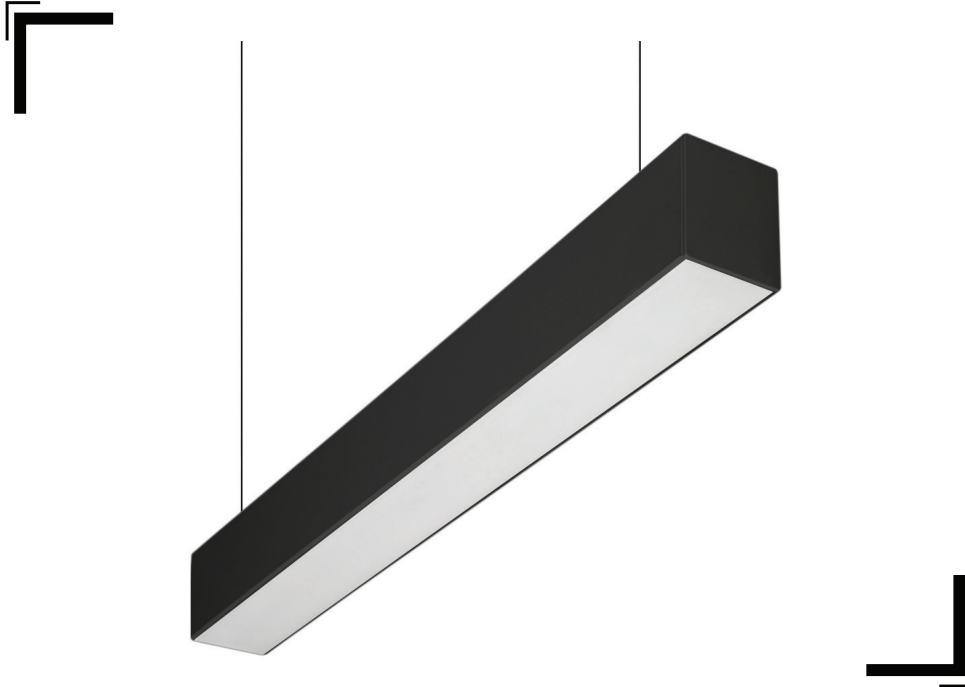

2700K - 6500K

Control a light source's color temperature output.
Works with DALI driver

PHOTOMETRICS

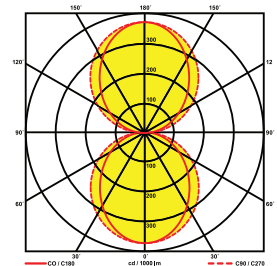

CODE*	APP	LENGTH (cm)		CRI	CCT	DRIVER	OPTIC	COLORS	
95	APP1 (1)	58 (058)	254 (254)	80 (8)	2700 (27)	ON-OFF (C)	OPAL (0)	WHITE (01)	
		86 (086)	282 (282)		3000 (30)	PUSH BUTTON (B)		BLACK (03)	
		114 (114)	310 (310)		4000 (40)	1-10V (V)		ALUMINUM (26)	
	APP2 (2)	142 (142)	338 (338)	5000 (50)			PHASE CUT (P)	STRIPED (S)	WALNUT (52)
		170 (170)	366 (366)					BIRCH (54)	
		198 (198)	394 (394)		6500 (65)	DALI (D)		MICRO- PRISMATIC (M)	WENGE (51)
	APP3 (3)	226 (226)	422 (422)	TUNABLE WHITE (TW)			SAFETY (S)		MARBLE (53)
		226 (226)	450 (450)						
		226 (226)	450 (450)						
	FINAL CODE								
	95	- (APP)	--- (LENGTH)		- (CRI)	--- (CCT)	--- (DRIVER)	- (OPTIC)	*** --- (COLORS)
						TUNABLE WHITE TW			

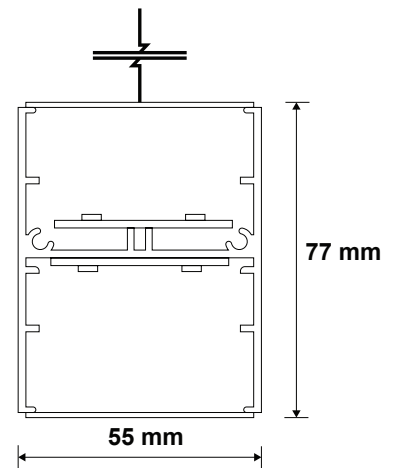

INSTALLATIONS

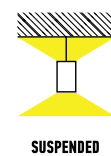

INSTALLATIONS WITH WALL BASE

*** PREFIX (T)



*To create the final product code add after their original prefix the orange numbers or letters, inside the parentheses, according to your choice.

*Για να δημιουργήσετε τον τελικό κωδικό προϊόντος χρησιμοποιήστε τα πορτοκαλί πρόθεμα ή γράμματα, που βρίσκονται μέσα στην παρένθεση.

*** Use prefix (T) in case that you need wall base for up-down installation.

*** Χρησιμοποιήστε το πρόθεμα (T) όταν θέλετε βάση τοίχου για up-down τοποθέτηση.

ATLAS 55 LED UP-DOWN

LENGTH (mm)	APP. 1			APP. 2			APP. 3		
	3000K	4000K	POWER	3000K	4000K	POWER	3000K	4000K	POWER
	LUMEN		WATT	LUMEN		WATT	LUMEN		WATT
580	1997	2123	11.1	2734	2910	15.8	3586	3822	21.6
860	2996	3184	16.7	4101	4365	23.7	5379	5732	32.4
1140	3995	4246	22.2	5468	5820	31.6	7172	7643	43.2
1420	4994	5307	27.8	6836	7275	39.5	8965	9554	54
1700	5992	6369	33.3	8203	8730	47.4	10758	11465	64.8
1980	6991	7430	38.8	9570	10185	55.3	12552	13376	75.5
2260	7990	8492	44.4	10937	11640	63.2	14345	15287	86.3
2540	8988	9553	49.9	12304	13095	71.1	16138	17197	97.1
2820	9987	10615	55.5	13671	14550	79	17931	19108	107.9
3100	10986	11676	61	15038	16005	86.9	19724	21019	118.7
3380	11985	12737	66.6	16405	17460	94.7	21517	22930	129.5
3660	12983	13799	72.1	17772	18915	102.6	23310	24841	140.3
3940	13982	14860	77.6	19140	20370	110.6	25104	26752	151
4220	14981	15922	83.2	20506	21825	118.5	26896	28662	161.9
4500	15980	16984	88.8	21874	23280	126.4	28690	30574	172.6

Lumen and watt table for led source. / Lumen και watt της πηγής

* Available in other sizes upon request.

* Διαθέσιμο και σε άλλα μεγέθη κατόπιν παραγγελίας

✓ **Tc:45°C**

Optimized heat conduction through "H" design extrusion

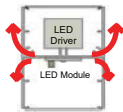

✓ **Seamless**

Continuous illumination with linear or angular application



Maintaining 80% of luminosity at 50.000 operating hours



5 years Warranty in conjunction with the corresponding driver.



WHITE (01)



BLACK (03)



ALUMINUM (26)



MARBLE (53)

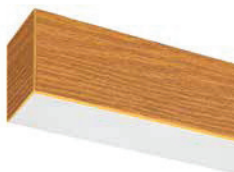

WALNUT (52)

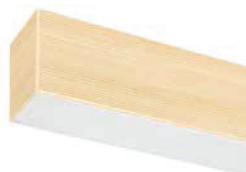

BIRCH (54)



WENGE (51)

ATLAS 55 LED UP-DOWN

Opal Diffuser

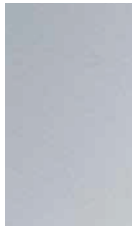

Light Absorption: 8,3%
Angle Diffusion: >90°
For general use
(not suitable PC tasks).

Microprismatic



Light Absorption: 10%
Angle Diffusion: 60°
For offices and
work spaces.

Striped Diffuser

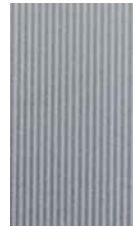

Light Absorption: 10%
For applications with
smaller UGR.
For extra comfort.

BODY

SOURCE

ELECTRIC EQUIPMENT

OPTIC EQUIPMENT

Extruded aluminum, powder coated or anodized

Philips Fortimo LED Strip Module of European origin

Constant Current LED Driver: On/Off • Dali • Dim 1-10V with Dimmer • Phase Cut
made from PMMA

CHARACTERISTICS

UPON REQUEST

REGULATION

SPECIAL APPLICATIONS

AVAILABLE COLORS

CRi 80 • CCT 3000K - 4000K • Colour Consistency 3 - 4 SDCM • Ingress Protection IP 40

CCT 2700K - 3500K - 5000K - 6500K • CRi 90

Manufactured in accordance with the Regulation EN 60598-1 and CE 93/68 EOK

Combination of architectural and decorative lighting

See the color chart and specific RAL upon request

A premium LED luminaire, made of high quality extruded aluminum profile, which provides 120° continuous lighting.

Available in multiple dimensions and finishes (powder coated or anodized). Suitable for professional and/or commercial spaces and stores.

Optimal heat conduction through "H" designed aluminum extrusion.

Seamless lighting in linear or angular application.

Code 96501 for mounting set 1,5m long. For each extra meter of wire rope, code 202020

2 or more mounting sets required for suspended lights.

Base available for up-down installation.